

Bendco and Houston Pipe Benders: The Leaders in Coiling and Induction Bending

Induction & Cold Bending

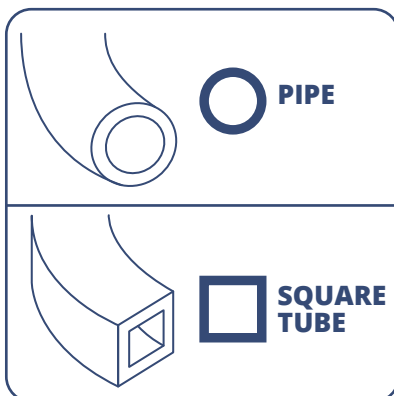
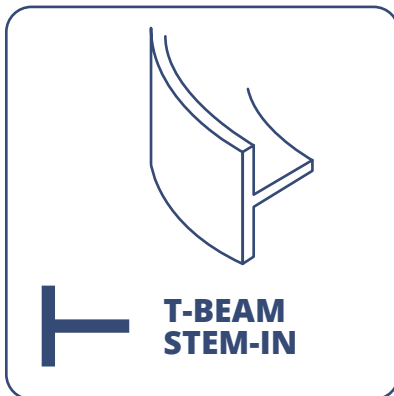
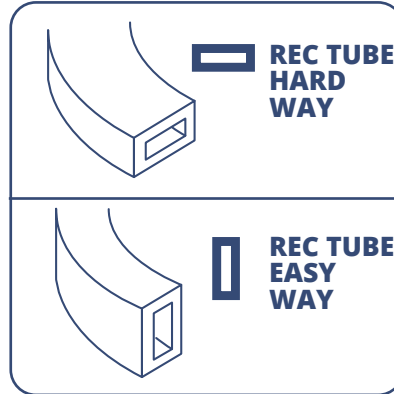

Bendco and Houston Pipe Benders: The Leaders in Coiling and Induction Bending

Induction & Cold Bending

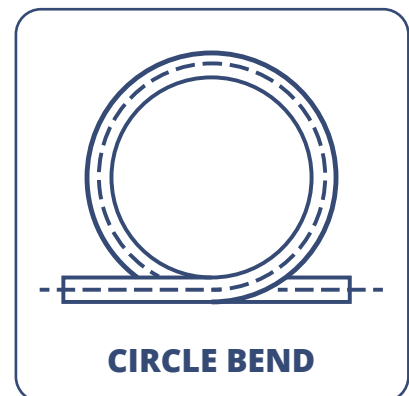
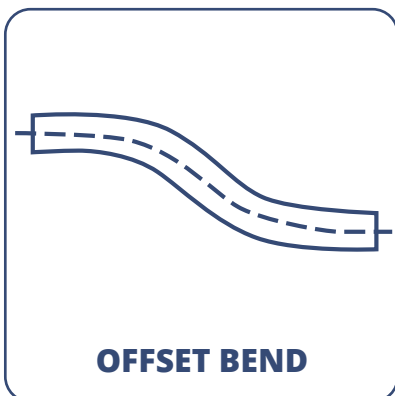
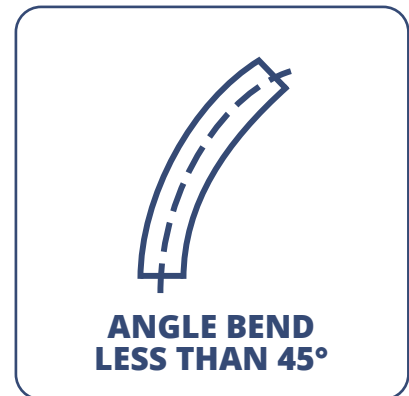
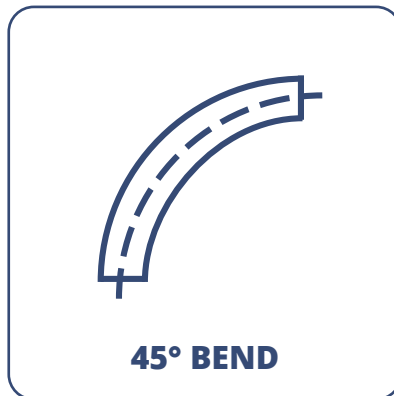
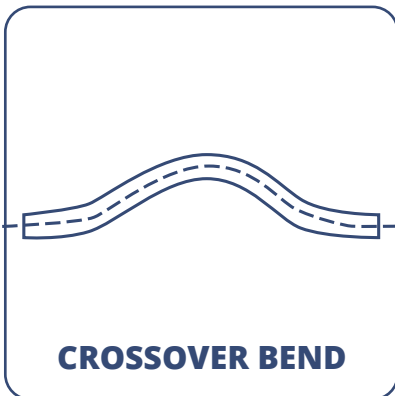
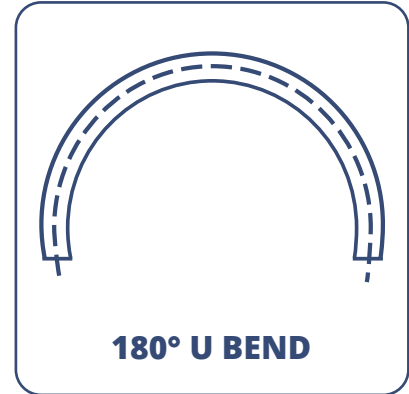
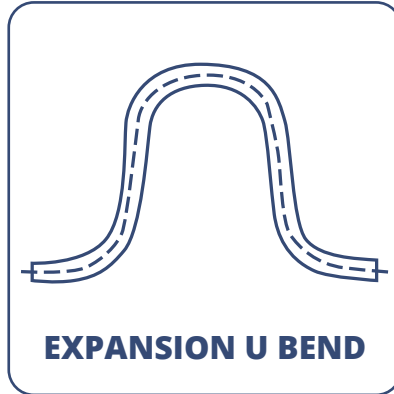
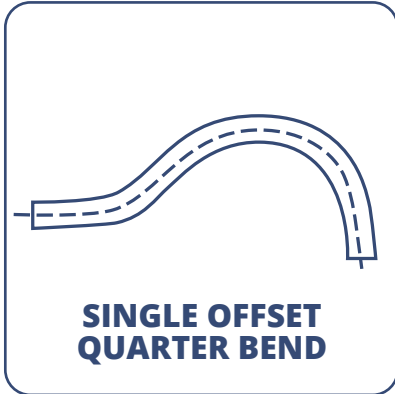

Visit us on the web at:
Bendco.com and HPBenders.com

Bendco and Houston Pipe Benders: The Leaders in Coiling and Induction Bending

Induction & Cold Bending

ANGLES

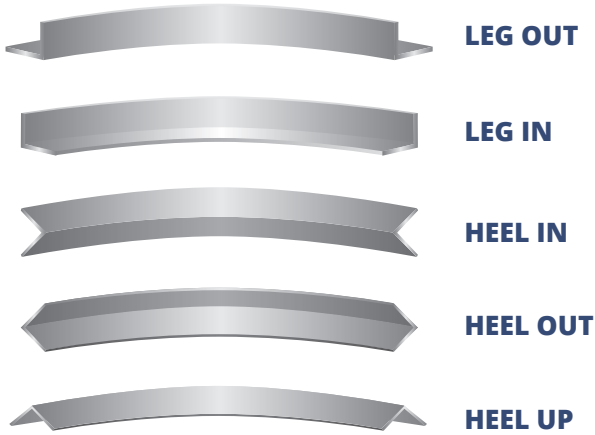

CHANNELS

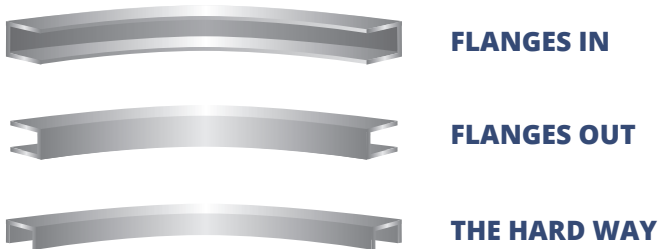

TEES

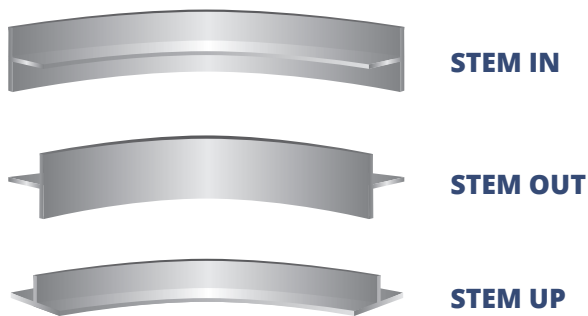

BARS

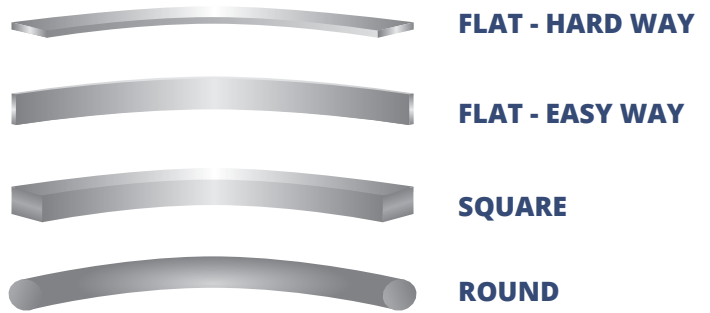

TUBES & PIPES



BEAMS



RAILS

