

Induction & Cold Bending

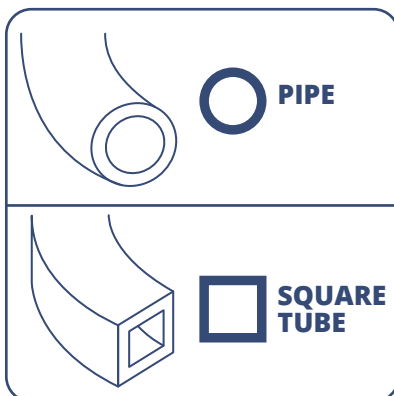

Induction & Cold Bending

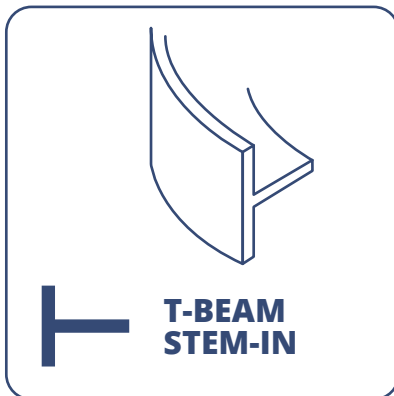
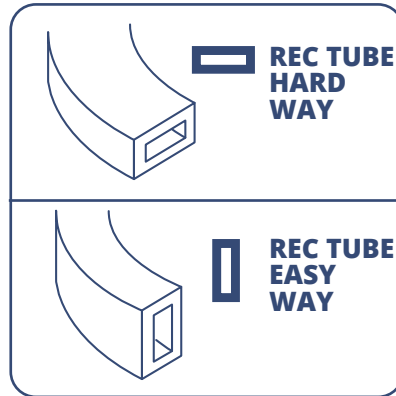
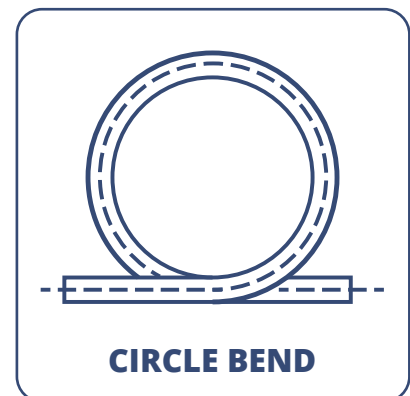
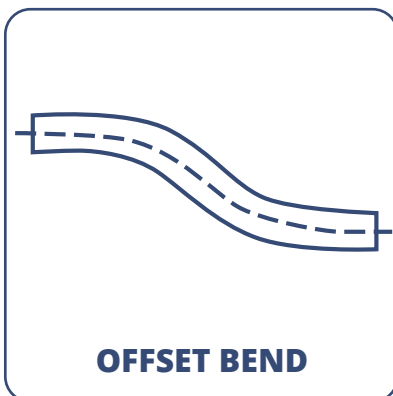
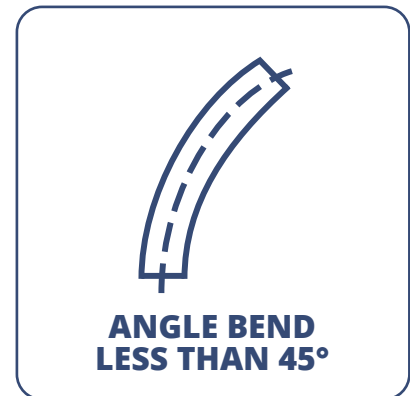
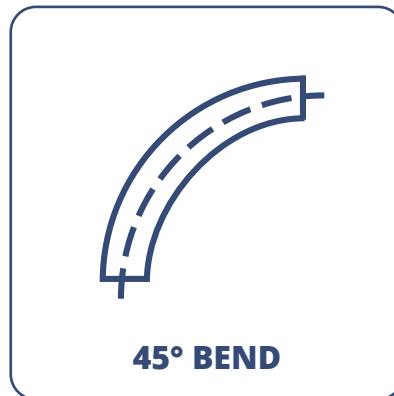
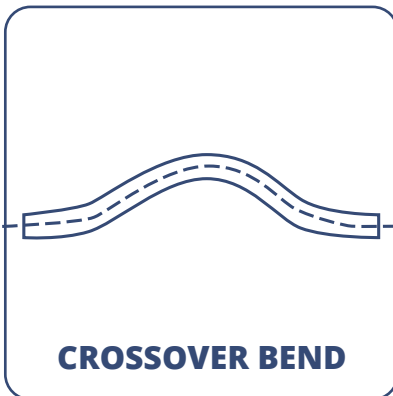
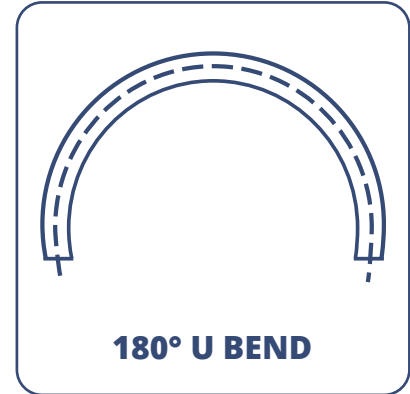
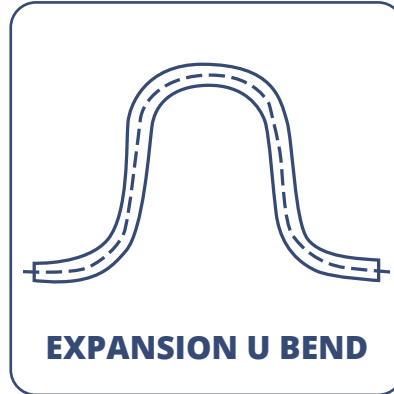
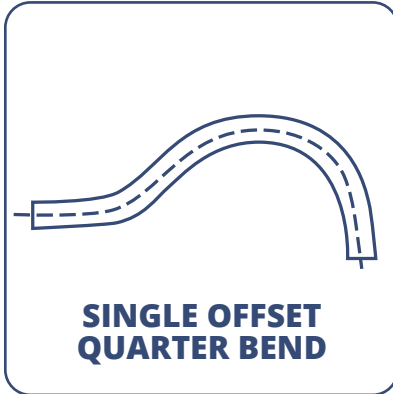

Induction & Cold Bending

ANGLES

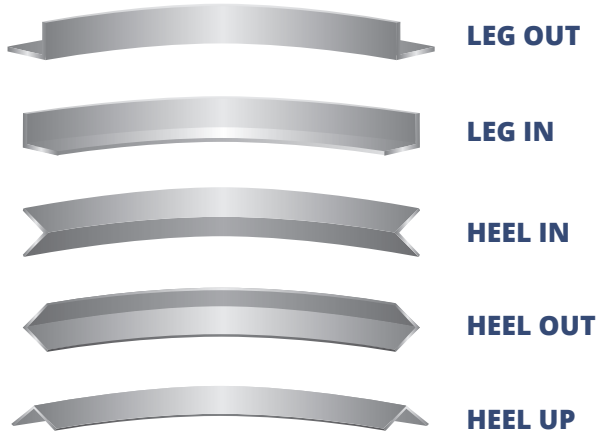

CHANNELS

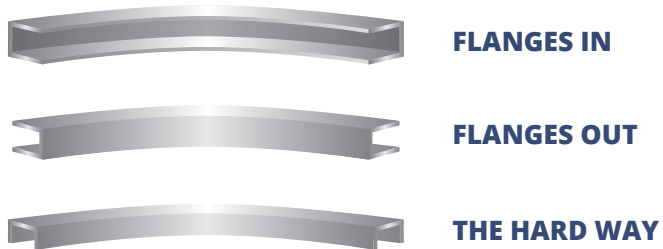

TEES

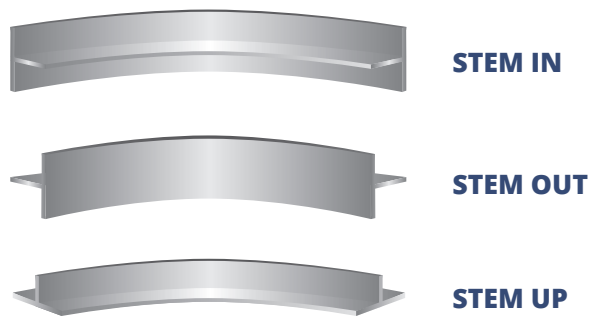

BARS

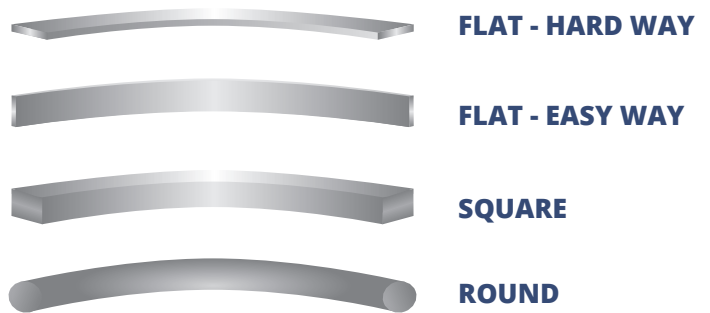

TUBES & PIPES



BEAMS



RAILS

